

# OPTIMIZATION OF A PHOTOVOLTAIC GENERATOR WITH A NEW SOLAR TRACKER

IS.BRAHAMI<sup>1</sup> M.BRAHAMI<sup>1</sup> A.TILMATINE<sup>2</sup>

<sup>1</sup> Intelligent Control and Electrical Power System Laboratory, Djillali Liabes University, Sidi Bel Abbes, 22000, Algeria.

[imenbousmaha@yahoo.fr](mailto:imenbousmaha@yahoo.fr) [mbrahami@yahoo.com](mailto:mbrahami@yahoo.com),

<sup>2</sup> APELEC Laboratory Djillali Liabes University, Sidi Bel Abbes, 22000, Algeria.

[atilmatine@gmail.com](mailto:atilmatine@gmail.com)

MA.SENOUSSAOUI

Intelligent Control and Electrical Power System Laboratory, Djillali Liabes University, Sidi Bel Abbes, 22000, Algeria.

[senoussaoui.mohammed@yahoo.fr](mailto:senoussaoui.mohammed@yahoo.fr)

**Abstract:** *Electricity generation using conventional sources such as fossil fuels raises a lot of problems either economically since it is a non-renewable or environmentally, due to the release of greenhouse gas that are the main causes of global warming. Electrical energy from photovoltaic effect provides an alternative to that produced in fossil energy power plants since it is sustainable and environmentally friendly. Many kinds of research have been conducted and still developing in order to improve overall solar system's efficiency and especially photovoltaic ones. The solar tracker is one of the elements that contribute to increase the maximum power captured from solar panels by adjusting their position in an optimal direction towards the sun. In this paper, the design of low cost, solar generator provided with a new single axis tracker (east-west) for a predetermined inclination of 30 degrees was developed. This new tracker, on sunny days, can increase the generation of the power station by 30% in comparison with a fixed system, even if it is made of cheap material, such as resistors and transistors. The generator follows the sun using a low power motor connected to a force multiplier; which provides a low energy consumption.*

**Key words:** *Photovoltaic generator, Solar panels; tracker; yield, optimization*

## 1. Introduction

Consumption of electrical energy in the world is constantly growing. Most of the used and produced electrical energy is obtained by the combustion of fossil fuels or by nuclear process. Thermal power plants and nuclear power plants are the main polluters of the environment. On the other hand, alternative energy sources that we are surrounded with represent pure ecological energy ones [1]. Huge technological and political efforts need to be done to encourage the use of the sun's energy more directly. It is one of the most inspiring challenges facing today's engineers and scientists [2]. Solar Energy is a good choice for electric power generation since the solar energy is directly converted into electrical energy by solar panels [3]. The

implementation of solar energy in recent years increased quickly and that's why we need to improve the materials and methods used to take advantage of this energy source [4].

However, to collect as much solar radiations as possible, it is more convenient and efficient to use a solar tracking system. In photovoltaic tracking systems, the surface of the module tracks the sun the whole day. In order to ensure maximum power output from PV cells, the sunlight's incidence angle needs to be constantly perpendicular to the solar panel. Solar tracking systems provide an increased annual efficiency, up to 35% of energy production [5]. Efficiency values vary according to seasons and especially in the winter months and are higher when using a solar tracking system than that of a fixed system [6].

Many studies have been done on the control methods to fulfill the expectations in many systems, including the solar tracking systems.

There is a great number of works proposed by many researchers to track the sun. A tracking system which can be used with single-axis solar concentrating systems is suggested by [7, 8]. Two axis-tracking systems are constructed and tested by [9, 10]. [11] described mainly the performance of PV modules with daily two-positions, in the morning and in the afternoon. [12] designed the solar tracking system called "one axis three positions sun tracking PV module" with low concentration ratio reflector. The single-axis tracking mechanism adjusted the PV panels' position only at three fixed angles corresponding to the morning, the noon and the afternoon. An experiment performed by [13] indicated that economic analysis showed that the price reduction was between 20% and 30% for the various market prices of flat plate PV modules.

In order to improve the production efficiency of the photovoltaic solar generator supplying an ozone water

treatment process, [14] used the experimental design methodology to find the optimal direction of the panels. In this work, the particular case of a cloudy weather was analyzed. For Sidi Bel Abbes city, Algeria, where the experiment was carried out, a north-south angle of  $30^\circ$  was the appropriate position for three different east-west orientation angles, corresponding to the morning, the afternoon and the evening periods.

The aim of this paper is to optimize a 810 Watt solar generator provided with a new low-cost one-axis solar tracker using basic electronic components such as transistors and resistors. The control circuit is composed only of Light dependent resistors (LDR) and a microcontroller (PIC876FA). The driving motor is connected to a force multiplier, which makes the PV panels consuming low power estimated equal to 60 Watt. The tilt angle of the photovoltaic generator will be following the east-west orientation, from east to west with a fixed north-south inclination of  $30^\circ$ , which was already optimized in a previous work [14].

## 2. Design of the photovoltaic generator

Before introducing the solar tracker, a photovoltaic generator of 810 Watt is built, which is consisting of 6 panels of 135 watts each; 4 of them are of polycrystalline type and the 2 others are mono-crystalline. Furthermore, the set-up comprises a conversion cabinet containing charge controllers and the inverter (Figure 1).



Fig. 1. The photovoltaic system used in the study.

The PV system is arranged in a way that each pair of identical modules is connected in parallel to a charge controller. The characteristics of the modules are given in Table 1.

Table 1  
Photovoltaic panel specifications

Parameters	Value
Standard illumination	1000 W/m <sup>2</sup>
Standard temperature	25 °C
Maximum peak power	135 W
Maximum Voltage, $V_m$	17.78 V
Maximum current, $I_m$	7.59 A
Open circuit voltage, $V_{co}$	22.26 V
Short-circuit current, $I_{co}$	8.28 A

The outputs of the three controllers are connected up to the terminals of the inverter through a connector block. The control of the east-west orientation is provided by a torque multiplier plugged into a low power engine (Figure 2). In addition, the North-South inclination is ensured by a hydraulic jack using a crank.



Fig. 2. Back view of the generator showing the effort multiplier and the hydraulic jack

### 3. Design of the solar tracker

The tracker is composed of two parts:

#### a) Control circuit

For economic, simplification and efficiency reasons, the control is provided by a 16F876A PIC microcontroller supplied with a 5V regulated power supply. The command signals of the microcontroller are obtained by the variation of the light dependent resistor (LDR).

#### b) Power Circuit

The power circuit of the tracker which is also used by [15] for another application, is composed of simple and basic components (resistors, transistors) and low power motor connected to a force multiplier (Figure 3). This circuit is composed of a transistor bridge feeding the motor in positive and negative voltage alternately. The motor works during all the day long in the same direction, pursuing the sun. In the evening during the sunset, the motor turns in the opposite way to position itself Eastwards for the next day.

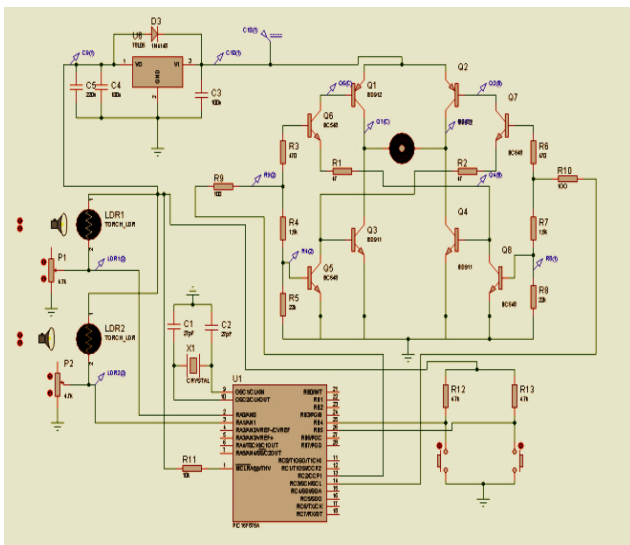

Fig. 3. Overall circuit of the tracker

The operation of the tracker is achieved according to the steps of the algorithm shown below:

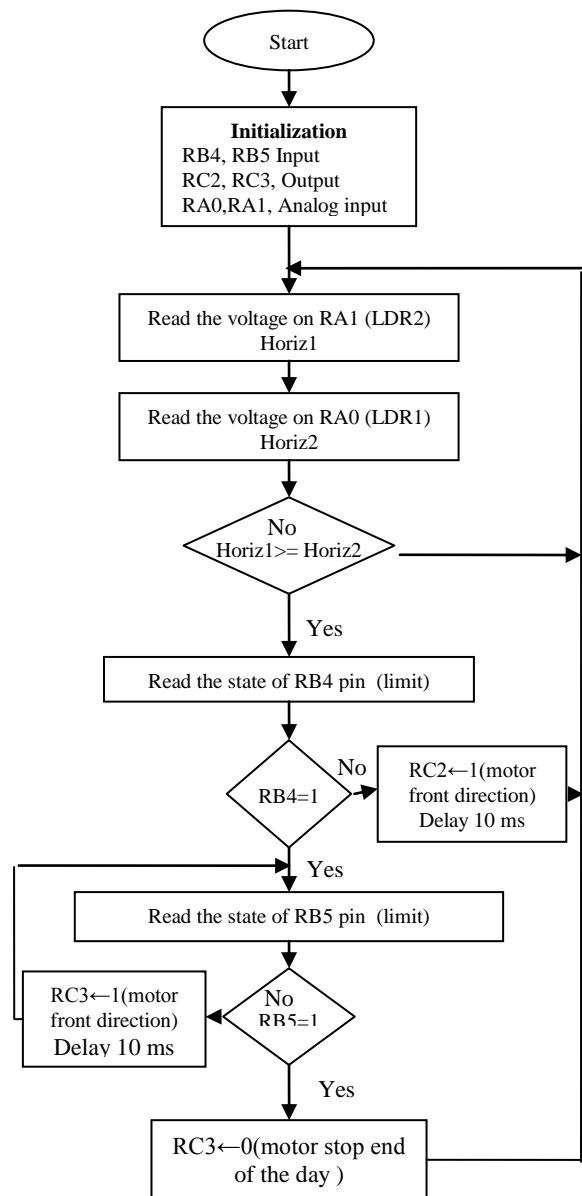

Fig. 4. Tracker control algorithm

A command routine was implemented with the microcontroller, and the digital-to-analog (D/A) converter integrated in the circuit was configured, to start automatic tracking.

The LDR sends an analog electric signal to ports RA0/AN0, RA1/AN1 (horiz1, horiz2) of the PIC. During the day, this latter compares the values of the two voltages: if  $\text{horiz1} \geq \text{horiz2}$ , the PIC sends a signal to the electronic switches through PIN RC2, causing motor rotation in the forward direction, and

then the motor stops.

After the sunset, the engine sends a signal to the PIC by "limit" PIN RB4 and the PIC sends a signal to the electronic switches through the PIN RC3 causing the rotation of the motor in the reverse direction to the original position, then the engine sends another signal to the PIC by "PIN RB5 initial position" and the motor stops (Fig.5).

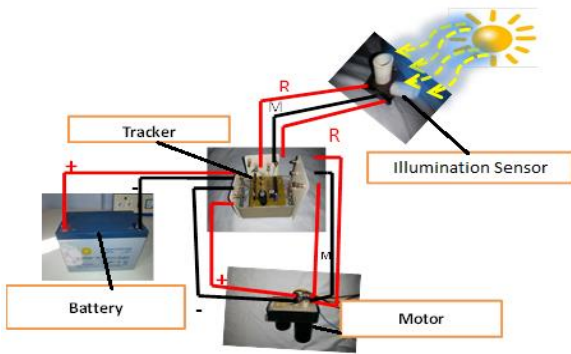

Fig. 5. Wiring diagram of the tracker

#### 4. Results and discussion

A set of experiments was to characterize the PV array and to check the effectiveness of the developed tracker mounted on the generator, as follows figure 6.

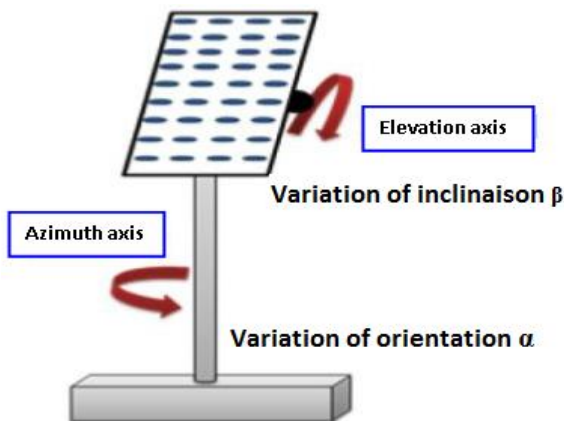

Fig. 6. Variation of inclination and orientation angles

- The generator is directed towards the south with an inclination  $\beta = 30^\circ$
- The East-West orientation  $\alpha$  of the generator was varied, while  $\beta = 30^\circ$  is kept constant

The optimal values of voltages ( $V_{op1}$ ,  $V_{op2}$ ) and currents ( $I_{op1}$ ,  $I_{op2}$ ) for the two considered technologies (mono and polycrystalline) were measured

as a function of illuminance and temperature.

#### a) Position of the generator fixed at ( $\alpha = 0^\circ$ and $\beta = 30^\circ$ ) without tracker:

In this section, the PV generator was directed towards the south with a north-south inclination of  $30^\circ$ , then at each hour the voltages and currents  $V_{op1}$ ,  $V_{op2}$ ,  $I_{op1}$  and  $I_{op2}$  were measured according to the illuminance  $E$  and the temperature  $T$ ; this operation is performed for several days. The obtained results for a typical day are reported in table 2.

Table 2  
Variation of  $V_{op1}$ ,  $V_{op2}$ ,  $I_{op1}$  and  $I_{op2}$  according to  $E$  and  $T$  ( $\alpha = 0^\circ$ ,  $\beta = 30^\circ$ ) during the day

Time	E (Lux)	T(°C)	$V_{op1}$	$V_{op2}$	$I_{op1}$	$I_{op2}$
09 a.m	470	20.1	19.2	19.6	5.6	5.8
10 a.m	637	23.3	20.1	20.4	8.3	8.6
11 a.m	1080	27	19.2	19.6	11.8	12.9
12 a.m	1210	23	20	20.3	13.4	14.5
01 p.m	800	22	19.8	20.2	11.4	13.7
02 p.m	1200	25	20.7	20.9	13.6	14.4
03 p.m	1060	26	20	20.3	12.2	12.9
04 p.m	900	26	20.1	20.3	12.2	12.9
05 p.m	545	27	19.4	19.8	6.5	6.7

The evolution of the current and the voltage of the modules in parallel during the day, for the two solar panel technologies (polycrystalline and monocrystalline), is shown in Figures 7 and 8 respectively.

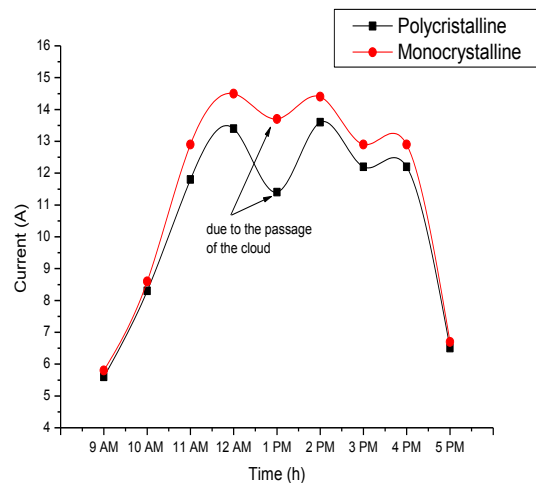

Fig. 7. Evolution of the current during the day using polycrystalline and monocrystalline solar panels

As shown in Figure 7 and Table 2, the current increases proportionally with the illumination from 9 a.m. to noon. At 01 p.m., as the illumination starts decreasing the current dropped due to the partial shading caused by cloud passage. At 02 p.m., the illumination and the current continues to decrease until the end of the day. Furthermore, the current generated using the monocrystalline modules is higher than that produced by the polycrystalline modules.

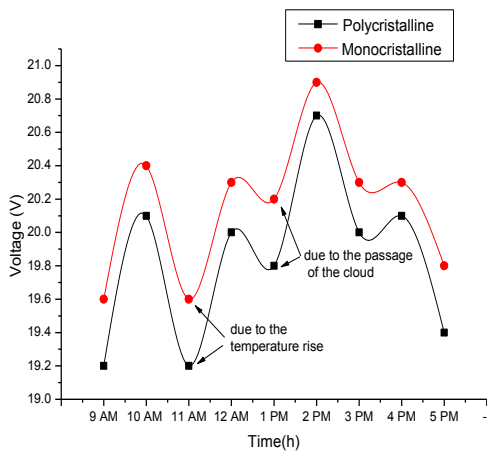

Fig. 8. Evolution of the voltage during a typical day for polycrystalline and monocrystalline solar panels

On the other hand, as seen in Figure 8 and table 2, the voltage depends strongly on the temperature, which increases with the reduction of the temperature and vice versa. Thus, at 11 o'clock a.m. The voltage decreased with temperature. At 02 o'clock p.m, it increases again with temperature. When comparing the PV modules technologies we found that the voltage, like the current, is higher in the case of monocrystalline modules than that of the polycrystalline modules.

**a) Position of the generator fixed at  $\beta = 30^\circ$  using the tracker**

In the following experiments, the tracker operates, causing the rotation of the generator following the angle  $\alpha$ , then observing their effects on the output variables such as voltages and currents. The measurement of  $V_{op1}$ ,  $V_{op2}$ ,  $I_{op1}$  and  $I_{op2}$  was carried out each hour from 9 a.m to 5 p.m during several days, as a function of illuminance  $E$  and temperature  $T$ . The obtained results of a typical day are given in table 3.

Table 3

Variation of  $V_{op1}$ ,  $V_{op2}$ ,  $I_{op1}$  and  $I_{op2}$  according to  $E$  and  $T$  ( $\alpha = \text{variable}$ ,  $\beta = 30^\circ$ ) during the day

Time	E (Lux)	T(°C)	$V_{op1}$	$V_{op2}$	$I_{op1}$	$I_{op2}$
09 a.m	1050	20.1	20	20.4	13	14.3
10 a.m	1066	23.3	20.2	20.6	13.4	14.4
11 a.m	1300	27	19.3	19.7	13.5	14.8
12 a.m	1327	23	20	20.3	14.5	16
01 p.m	800	22	19.8	20.2	11.4	13.7
02 p.m	1230	25	20.6	20.8	13.8	15.1
03 p.m	1215	26	20.2	20.4	13.7	14.7
04 p.m	1250	26	20.1	20.5	13.7	15.4
05 p.m	1000	26.5	20.1	20.4	11.6	12.6

The graphical representation of the variation of the voltage and the current is shown in Figures 9 and 10

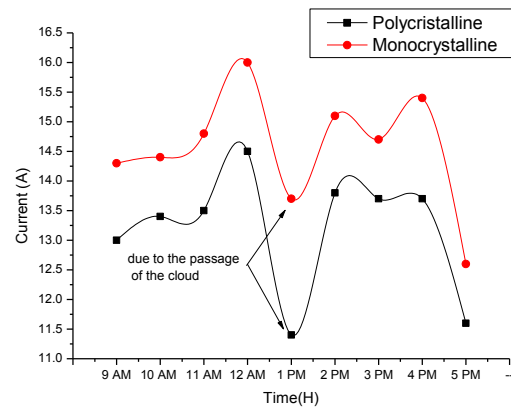

Fig. 9. Evolution of current using the tracker during one sample day for two different PV technologies

As seen in Fig.9 and table 3, it is clearly noted that the current varies proportionally with the illuminance depending on the hour of the day. Around 01 o'clock p.m. A diminution of the current at the output of the panels accompanied by a decrease of illumination intensity was observed as a result of the clouds shading. In addition, Furthermore, The current of a monocrystalline modules is always higher than that of poly crystalline modules.

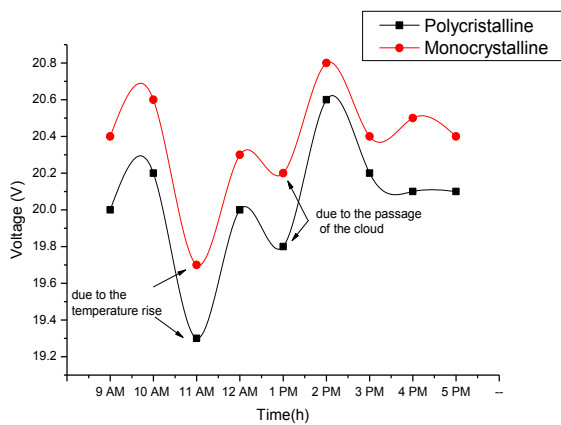

Fig. 10. Evolution of voltage using the tracker during one sample day for two different PV technologies

At 11 am o'clock the voltage has dropped due to the temperature rise. On the other hand the voltage strongly depends on the temperature (Figure 10 and table 3). The tension increases with the reduction in the temperature and vice versa. Furthermore, the voltage in the monocrystalline modules is always higher than that of polycrystalline modules.

From table 3 we can observe that the voltage is inversely proportional to the temperature. For example, at 11 o'clock a.m. the voltage has dropped due to the temperature rise and similarly at 12 o'clock, 03 and 05 o'clock p.m. Then, since the temperature varies in narrow field this affected a voltage variation which has also fluctuated in an interval around 20 V.

Figures 11, 12 and 13 presents a comparison of the illumination, current and voltage for a PV system with and without a tracker.

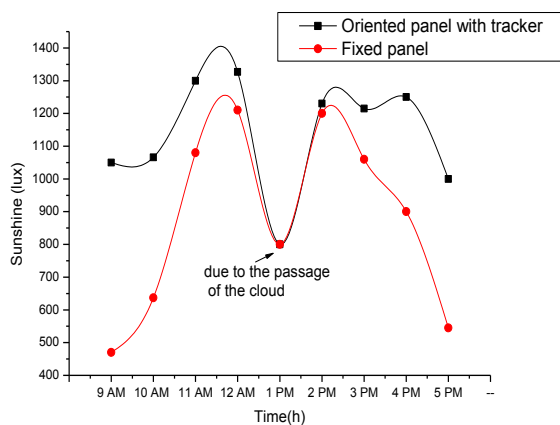

Fig. 11. Variation of illuminance during the day with and without tracker

It is clearly noted that a system with tracker receives much more illumination as indicated the measurements by lux meter and illustrated above in the graph of figure 11, because the panels are continually perpendicular to the sunlight.

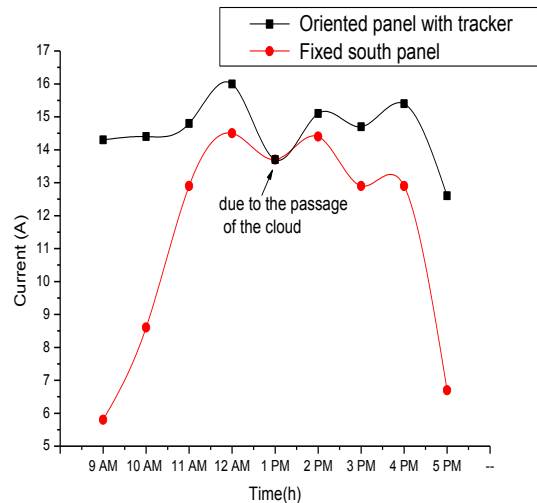

Fig. 12. Variation of current  $I_{op1}$  during the day with and without tracker.

The difference between the two systems, with and without tracker, is so high at the beginning and the end of the day because of that in a fixed system the panels were oriented upwards, but inclined towards the south with  $30^\circ$ ; so, only the borders and a small part of the surface of the panel were exposed to the sunlight in the early and late hours of the day, this lead to less illumination absorbance. The passage of clouds at 01 o'clock p.m provoking a partial shading of PV panels for the two systems, thus a sunshine and current decrease together. Moreover, they become in the same east-west position at this time, which cause a coincidence of measures (for either illumination and current or voltages).

In addition, the current is greater for a system with tracker with declination towards the end of the day (figure 12).

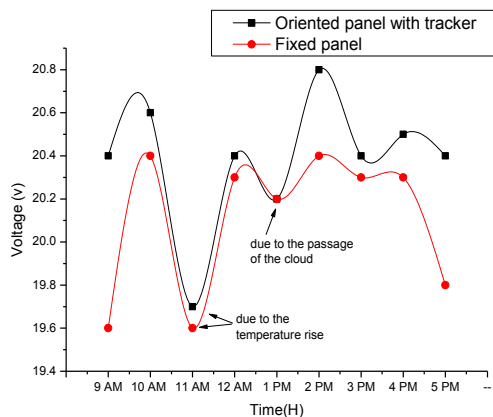

Fig. 13. Variation of voltage  $V_{op1}$  with and without tracker.

## 5. Conclusion

In this paper, two realizations were developed and analyzed. The first one is the PV generator of 810 Watts constituted of six modules connected in parallel; of which two are mono-crystalline and the rest are poly-crystalline.

The obtained results of the current and the voltage indicate that the mono-crystalline modules give a higher yield than that of polycrystalline. The second one relates to the sun tracking system. It is of simplified design, including only usual components such as transistors and resistors in the power circuit. The control is mainly performed by a16F876A microcontroller, which offers a very low price tracker. A low power motor was employed for the rotation of the PV generator. This helps in saving power recovered by the tracker. The measurement results show that the voltage is strongly dependent on the temperature and much less on the illumination, while the current depends much more on the illumination than on the temperature. Increasing the temperature above 25°C affects negatively in particular the PV panel voltage.

The power produced by the generator with tracker is much greater than that produced without the tracker. Some days the power difference exceeded 30%.

## References

1. Stjepanovic A., Softic F, Bundalo Z and Stjepanovic S : *Solar Tracking System and Modelling of PV Module*, MIPRO, Opatija, Croatia. 2010.
2. Breeze, P, B and da Rosa, A, V: *Renewable Energy Focus Handbook*, 1st ed, USA, Elsevier Inc, 2009.
3. Parallax. *Experiments with Renewable Energy Student Guide*, version 1. 2004
4. Clean Energy Decision Support Centre. *Photovoltaic project analysis*, Minister of Natural Resources Canada. Pp: 2001–2004
5. Brahami MN : *Réalisation d'une unite de production d'énergie électrique solaire pour site isolé (Realization of solar power production unit for isolated site)*. Doctorat thesis. Djillali Liabes University of Sidi Bel Abbes Algeria 2015
6. Huang YJ, Kuo, T.C, Chen C.Y, Chang C.H, Wu P.C, and Wu T.H.: *The Design and Implementation of a Solar Tracking Generating Power System*, Advance online publication. November 2009.
7. Kalogirou SA. *Design and construction of a one axis sun-tracking system*. Sol Energy 1996; 57 (6):465–9.
8. Alata M, Al-Nimr MA, Qaroush Y.: *Developing a multipurpose sun tracking system using fuzzy control*. Energy Convers Manage 2005; 46: 1229–45.
9. Roth P, Georgiev A, Boudinov H.: *Design and Construction of a system for sun tracking*. Renew Energy 2004; 29(3):pp:393–402.
10. Bakos GC.: *Design and construction of a two-axis sun tracking system for parabolic trough collector (PTC) efficiency improvement*, Renew Energy 2006; 31:2411–21.
11. Tomson T. *Discrete two-positional tracking of solar collectors*. Renew Energy 2008; 33:400–5.
12. Huang BJ, Sun FS.: *Feasibility study of one axis three positions tracking solar PV with low concentration ratio reflector*. Energy Convers Manage 2007; 48:1273–80.
13. S.Zubair, A.Suleiman, H.T.Abdulazzez, B.A.Salih.: *Design and construction of a microcontroller based single axis solar tracker*. Innovations in Science and Engineering, (2011)
14. Brahami MN, Hadjeri S, Nemmiche S, Brahami Mand Tilmatine A.: *Experimental investigation of a PV solar generator for supplying water treatment process*. International Journal of Environmental Studies, 2015 Vol. 72, No. 1, pp:207–221.
15. Shruti Shrivastava1, Jageshwar Rawat, Amit Agrawa.: *Controlling DC Motor using Microcontroller (PIC16F72) with PWM*, International Journal of Engineering Research Volume No.1, Issue No.2, pp: 45-47, 01 Dec. 2012