

# DESIGN AND IMPLEMENTATION OF PI CONTROLLER TUNED BY FUZZY LOGIC FOR WATER LEVEL CONTROL OF SPHERICAL TANK SYSTEM

**Lakshmanan M**

Bannari Amman Institute of Technology, Sathyamangalam  
Assistant Professor, Department of EEE, 04295-226000  
lakshmanan.muthuramu@gmail.com

**Dr.Ganesan R**

Saveetha Engineering College, Chennai  
Professor, Department of EIE, 044-66726677  
ganesanhod@gmail.com

**Dr.Kumar C**

Bannari Amman Institute of Technology, Sathyamangalam  
Associate Professor, Department of EEE, 04295-226000  
ckumarme81@gmail.com

**Abstract:** Many control problems are arising in chemical process industries due to the nonlinear dynamic behavior. The spherical tank system is one of the most enduringly popular and important process used in chemical industries. The water level of the spherical tank system is extremely complex to control, because of variation presents in the cross sectional area. For many years, the Proportional Integral (PI) controller is mostly used in process industries, due to their simplicity and flexibility. Hence the PI controller tuning parameters are very significant to control the water level of the spherical tank system. The real time implementations of spherical tank system with PI controller parameter tuning methods by means of tuned by fuzzy logic, Root Locus Technique and Z-N tuning method are used and also analyze the servo and regulatory responses for different set points.

**Key words:** Spherical tank system, PI controller, fuzzy logic, root locus technique, Nonlinear Systems.

## 1. Introduction

In process control industries, most of the processes are nonlinear nature because of their variables are always changing with respect to time and also the designing of the controller for such processes is very complicated. In this research work, consider one of the processes of spherical tank system used in process industry is carried out. The nonlinear spherical tank system is widely used in hydro- metallurgical industries, cement industries and concrete handling applications, thermal plant's coal handling section, food processing industries and waste water treatment plants [21][22][23]. The property of PI controller tuned by fuzzy logic is greater flexibility than conventional controllers and also growing very fast because of its simplicity and versatility. Most of the times, PI controller tuned by fuzzy logic has more robust than conventional controllers. The time domain specifications like

damping ratio and natural frequency are used to tuning the PI controller parameters using one among the proposed root locus technique. The proposed controller performance results are comparing with the existing Z-N tangent method. Anandanatarajan R et al. 2005 have proposed based on the transfer function model, the simulation study has carried out on the conical tank level process and the results are compared with conventional PI controller and the Smith PI controller. [1]. Anandanatarajan M et al. 2006 have proposed the servo and regulatory responses of conical tank system study through simulation and experimentation for various set-point changes and load changes with the PI controller tuning by Z-N tuning method. [2]. Basilio JC et al. 2006 have proposed Ziegler–Nichols step response method and root locus technique for tuning the PI controller parameters. [3]. Chen KY et al. 2009 have proposed self-tuning Fuzzy Proportional Integral Derivative controller to adjust the actuating signals in order to overcome the disturbances and reduces the unbalancing vibration. The experimental result gives better enhancement in reducing the vibration [4]. The performance of the gain scheduled PI controller has been discussed to control the liquid level of the two tank interacting spherical tank system (Dinesh Kumar et al. 2012) [5]. Prasanta Roy et al. 2016 has proposed fractional order PI controller for coupled two tank MIMO system and proved the FOPI controller gives better results along with conventional controllers [6]. Danica Rosinova et al. 2016 have proposed full state feedback PI controller and multi loop approach for three tanks system [7]. Houssemeddine Gouta et al. 2017 have proposed generalized model predictive controller for a coupled four tank MIMO system [8]. Pradeep KJ et al. 2016 have proposed PI controller for blending

process which can be modeled as first order plus dead time. Ziegler Nichols tuning method has been used for tuning the PI controller parameters and evaluated by comparing set point and disturbances [9]. Dharmana simhachalam et al. 2014 have proposed Proportional Integral Derivative (PID) controller tuned by fuzzy logic rules for integrating process with dead time. The simulation studies are proved the performance of the process has been excellent [10]. Rajni Jain N et al. 2011 have proposed the fuzzy based intelligent control schemes are designed for control of nonlinear tube heat exchanger such as single-input single output (SISO) and coupled two tank system such as Multi Input Multi Output (MIMO) systems. The experimental results demonstrate the self tuning fuzzy controller gives improved performance [11]. Taoyan Z et al. 2012 have proposed interval type to fuzzy controller for twin tank water level system. The simulation results on the twin tank water level system with fuzzy controller can reduce the uncertain disturbance from real world environment, better static and dynamic control than traditional fuzzy control method [12]. RE Precup et al. 2013 have proposed lyapunov's stability analysis method dedicated to a class of fuzzy control systems controlling the three spherical tank system like multi input-multi output (MIMO) nonlinear processes [13]. Abdullah Basci et al. 2016 have proposed an adaptive fuzzy control (AFC) for two coupled water tank system to control the level position. The experimental results are proved the controller gives better steady state and transient performance than well tuned conventional PI controller [14]. Based on the new ideas, the proposed research work has focus to design the PI controller parameters tuning. The experimental results of servo and regulatory responses show the efficiency of the control scheme.

## 2. Statement of problems and solution

The control of the water level in the spherical tank is very critical due to variation in their cross sectional area. Hence, the design of suitable controller is very important. The Proportional Integral (PI) controller is one of the leading controllers in industrial processes. So the PI controller tuning parameters are very significant to control the water level of the spherical tank system. In this paper, the proposed PI controller tuned by fuzzy logic and conventional methods are used to control the spherical tank system by experimentally.

## 3. Spherical Tank System

The layout of spherical tank system is as shown in Fig-1. The real time spherical tank system has one inlet and one outlet. The height of the spherical tank is 43 cm and made by stainless steel. The variable frequency drive (VFD) is used to pump the water from the storage tank. The VFD is operated from 0 to 50 Hz based on the input current varies from 4 to 20mA. The rotameter and flow transmitter (FT-1) are used to monitor the inlet water flow. The rotameter can allow the water from 150 lph to 1500 lph. The pneumatic control valve (CV-1) and manual hand operator valve (HV-1) are used to regulate the inlet water flow. The electrical signal 4-20 mA is converted to 3-15 psi by using current to pressure converter. Air compressor is supply the pressure to pneumatic control. The control valve (CV-1) is operating by supply the 3-15 psi pressure from pneumatic control. The orifice is used to restrict the pressure drop from flow transmitter. The flow transmitter can be used to convert differential pressure in to 4-20 mA electrical signals. An outlet water flow is measure by using outlet flow transmitter (FT-2) and to regulate the water flow by using pneumatic control valve (CV-2) to apply the 4-20mA current signal. The water level of the spherical tank system is measured by using level transmitter. Further the differential pressure is converting to 4-20mA current signal.

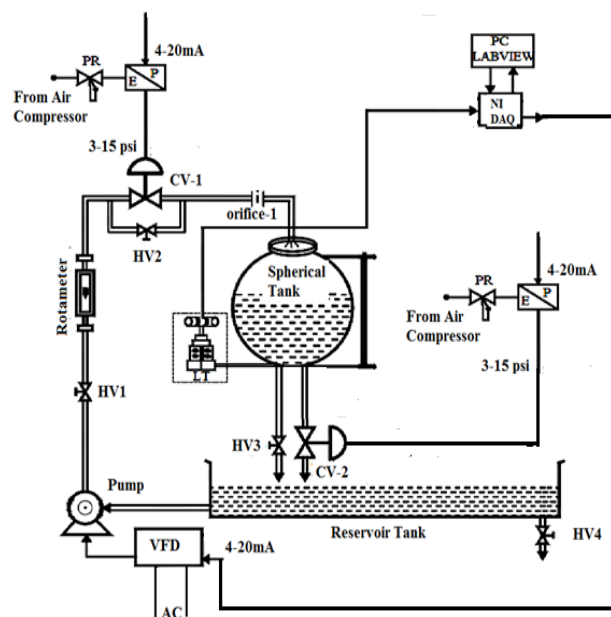

Fig. 1. Layout of spherical tank system

### 3.1 Process Modeling

The schematic diagram of the spherical tank system is shown in Fig-2 in which the water level of the spherical tank should attain to a desired set point. The desired set point is attained by controlling the input flow rate using control valves or variable frequency drive. In this research work, the mathematical modeling of the spherical tank system is considered for designing the conventional controller parameters [18][19].

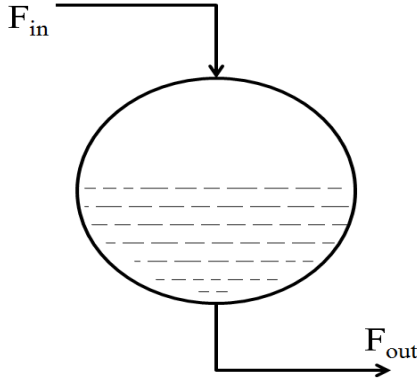

Fig. 2. Schematic diagram of spherical tank system

where,  $F_{in}(t)$  - input flow rate  $\text{cm}^3/\text{sec}$   
 $F_{out}(t)$  - output flow rate  $\text{cm}^3/\text{sec}$   
 Using the law of conservation of mass,

$$F_{in}(t) - F_{out}(t) = S(h(t)) \frac{dh(t)}{dt} \quad (1)$$

$h(t)$  represents the liquid level and  $S(h(t))$  is the slanting section of the tank. The water level in the spherical tank at any instant as given below:

$$S(h(t)) = \pi(2Rh(t) - h^2(t)) \quad (2)$$

where  $R$  represents for the radius of the spherical tank.

Let us consider the interruption given by changing the output flow rate and it can be represented as,

$$F_{out}(t) = C_p \sqrt{2gh(t)} \quad (3)$$

Substituting Equations (2) and (3) in equation (1)

$$F_{out}(t) = \pi(2Rh(t) - h^2(t)) \frac{dh(t)}{dt} \quad (4)$$

The nonlinear model of the spherical tank system can be described

$$\frac{dh(t)}{dt} = \frac{F_{in}(t)}{\pi(2Rh(t) - h^2(t))} - \frac{C_p \sqrt{2gh(t)}}{\pi(2Rh(t) - h^2(t))} \quad (5)$$

$$\frac{dh(t)}{dt} = f(F(t), h(t)) \quad (6)$$

The spherical tank system nonlinear model is transformed in to linearized model because of better clarity and it handles in conventional way. The linearized process dynamics are described in terms of first order differential equations as follows:

$$\frac{dh(t)}{dt} = A(F_{in0}, h_0)h(t) + B(F_{in0}, h_0)F_{in}(t) \quad (7)$$

The constant  $A(F_{in0}, h_0)h(t)$  and  $B(F_{in0}, h_0)$  of the linear process model given by factorial derivatives,

$$A(F_{in0}, h_0) = \frac{\partial f(F_{in}(t))}{\partial h(t)} |_{h_0(t), F_{in0}(t)} \quad (8)$$

$$B(F_{in0}, h_0) = \frac{\partial f(F_{in}(t))}{\partial F_{in0}(t)} |_{h_0(t), F_{in0}(t)} \quad (9)$$

The traditional representation of the spherical tank process with time constant  $\tau$  and process gain  $K$  are given, both of which are robustly dependent on the operating point  $h_0(t)$  and  $F(t)$ . Taking Laplace transforms of Equation (7) and substituting the values of  $A$  and  $B$ , the final spherical tank system is represented in equation (10)

$$G(s) = \frac{K}{\tau s + 1} \quad (10)$$

where, time constant

$$\tau = \frac{\pi \sqrt{2gh_0(t)}}{C_p g} (2Rh_0(t) - h_0^2(t))^2 \quad (11)$$

### 3.2 Model Identification

In this paper, one of the open loop identification techniques like process reaction curve method is implemented to identify the model of the spherical tank system. The open loop test is conducting by experimentally and the gain is determined from the step input and final steady state value of the output. The time constant ( $\tau$ ) and the dead time ( $t_d$ ) are calculated based on the process reaction curve method. Then the model is represented by equation (12)

$$G(s) = \frac{K_p e^{-t_d s}}{\tau s + 1} \quad (12)$$

where,  $K_p$  represents process gain

Time constant  $\tau = 1.5(t_2 - t_1)$

$t_1$  represents the time taken by the height to attain 28.3% and  $t_2$  represents the time taken by the height to attain 63.2%.

$t_d$  represents time of delay.

Due to reduce the difficulty, the entire operating region of the spherical tank (43 cm) has been categorized into three operating regions. Based on the operating regions, three linear transfer function models are derived and used for further analysis and also model parameters are listed as shown in Table 1.

Table 1. Linear models of spherical tank system

Operating regions	Process gain ( $K_p$ )	Delay time ( $t_d$ )	Time constant ( $\tau$ )
Lower range (0 cm to 12 cm)	9.43	-6	1280
Middle range (12.1 to 25 cm)	8.1	-5.44	1050
Higher range (25.1 to 43 cm)	7.23	-4.5	980

#### 4. Ziegler-Nichols (Z-N) Method

Ziegler - Nichols tuning method is developed for linear process model like that different form of tank system and correlating the controller parameters with features of the step response method. The controller parameters are tuned from quarter amplitude damping and the process dynamics was characterized by two parameters like delay time (L) and time constant (T) obtained from the step response. This Ziegler - Nichols tuning method is that it permits a clear tradeoff between robustness and performance [18][20][24][25].

$$\text{Proportional gain } K_p = \frac{0.9T}{L} \quad (13)$$

Integral time  $\tau_i$  which is given by

$$\tau_i = \frac{L}{0.3} \quad (14)$$

#### 5. Root Locus Technique

The root locus technique is developed for the linear control system. The controller parameters are calculated yields the locus of the positions of the dominant s-plane poles of the open loop transfer function. In this root locus technique, the proportional gain  $K_p$  and integral gain  $K_i$  are tuned based on damping ratio and natural frequency of the oscillations.[19][20].

Let us consider,

$$S_d = -\varepsilon\omega_n \pm j\omega_n\sqrt{1 - \varepsilon^2} \quad (15)$$

where,  $S_d$ =Dominant pole  
 $\varepsilon$  = Damping ratio

$\omega_n$  = Natural frequency of oscillation, rad/sec.

The transfer function of PI controller is represented by the equation (16),

$$G_c(s) = K_p + \frac{K_i}{s} \quad (16)$$

Proportional gain,

$$(K_p) = \frac{-\sin(\beta+\phi_d)}{A_d \sin\beta} - \frac{2K_i \cos\beta}{D} \quad (17)$$

Integral gain

$$(K_i) = \frac{-D \sin \phi_d}{A_d \sin\beta} \quad (18)$$

$$\text{Integral time } (\tau_i) = \frac{1}{K_i} \quad (19)$$

where,  $D$  = Magnitude of dominant pole ,

$\beta$  = Phase of dominant pole

$A_d$  = Magnitude of  $G(s_d)$ ,

$\phi_d$  = Phase of  $G(s_d)$

Using the above equations (17), (18) & (19) to find the proportional gain  $K_p$  and integral gain  $K_i$  are found to the PI controller. The Controller parameters for various operating regions of the spherical Tank system are shown in Table 2.

Table 2. Controller parameters for various operating regions of the Spherical Tank System

Operating regions	Proportional gain ( $K_p$ )	Integral Time constant ( $\tau_i$ )
Lower range (0 cm to 12 cm)	16.10	0.11
Middle range (12.1 to 25 cm)	21.63	0.14
Higher range (25.1 to 43 cm)	31.67	0.28

#### 5. Design of PI Controller tuned by fuzzy logic

The proposed PI controller tuned by fuzzy logic is as shown in figure 3. The real time implementation of non linear process with conventional PI controller parameters produces poor performance [15][16][17]. Hence to solve this poor performance, uses PI controller tuned by fuzzy logic in real time with high performance. So the proposed technique to fine-tune the PI controller parameters to control the water level of the spherical tank system. The fuzzy inference module with conventional PI controller is used to tune the proportional gain  $K_p$  and integral gain  $K_i$ . The PI controller parameters are adjusted by using fuzzy inference rules based on the error and

change in error. The experienced knowledge and fuzzy set theory are utilized to regulate the PI controller parameters. The structure of the fuzzy inference module includes two inputs and two outputs, where the input is error  $e$  and change in error  $ec$ , and the output is the gain parameters  $K_p$  and  $K_i$  of the PI controller.[17]

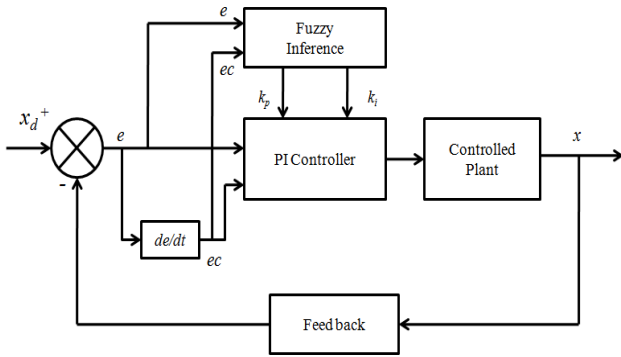

Fig. 3. Proposed PI controller tuned by fuzzy logic

#### 4.2. Fuzzification of input and output variables

The fuzzy inference system is established based on fuzzy set theory. The input and output data are transformed into proper value based on the fuzzification of the input and output variables. In this research work, the basic ranges of input and output variables are error, change in error  $[-43, 43]$ , Proportional gain  $K_p=[0,21]$ , Integral gain  $K_i=[0,1]$ . Then the input and output variables are transformed into uniform fuzzy range  $[1,1]$  and  $[0,1]$  for ease of design.

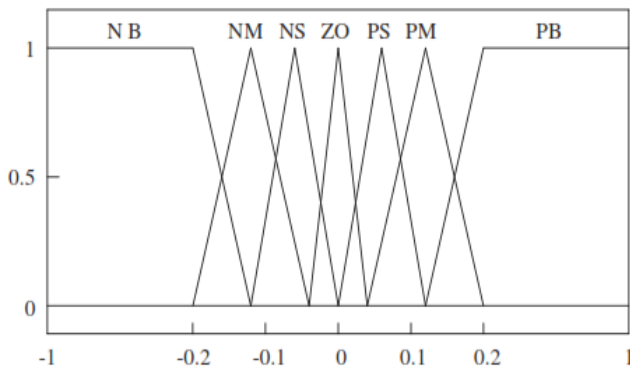

Fig. 4. Membership function of  $e$  and  $ec$ .

The fuzzy range of input and output is divided into 7 and 5 variables respectively, and the corresponding fuzzy subsets are  $e, ec = [NB, NM, NS, ZO, PS, PM, PB]$  and  $k_p, k_i = [SS, MS, MM, BM, BB]$  where NB is negative big; NM is negative middle; NS is negative

small; ZO is zero; PS is positive small; PM is positive middle; PB is positive big; SS is small; MS is middle small; MM is middle, BM is big middle; BB is big.

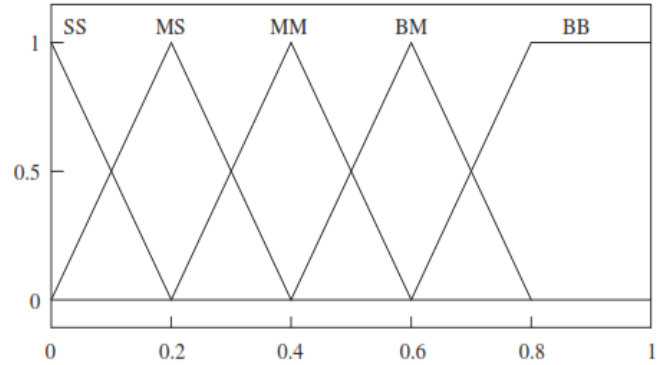

Fig. 5. Membership function of  $K_p$  and  $K_i$

The membership function of input variables and output variables are shown in figure 4 and 5. The NB and PB are trapezoidal membership function and others are triangular membership function. Let BB be trapezoidal membership function and others are triangular membership function. In order to achieve the performance indices, the fuzzy inference rules are framed based on input and output variables as shown in Table 3. If  $e$  is  $A_i$  and  $ec$  is  $B_j$ ; then  $k_p$  is  $C_{ij}$ ;  $k_i$  is  $D_{ij}$  and  $k_d$  is  $E_{ij}$ : where  $A_i, B_j, C_{ij}, D_{ij}, E_{ij}$  are fuzzy subsets of inputs and outputs, and  $i, j = 1, 2, 3, 4, 5, 6, 7$ .

#### 5. Experimental setup of spherical tank system

The Figure 6 shows the real time experimental setup of the spherical tank system.



Fig. 6. Real time experimental setup of the Spherical Tank System



Table 3. Fuzzy rules

e	ec						
	NB	NM	NS	ZO	PS	PM	PB
	$k_p/k_i$						
NB	BB/SS	BB/SS	BM/MS	BM/MS	BM/MM	MM/MM	MM/MM
NM	BB/SS	BM/SS	BM/MS	BM/MM	MM/MM	MM/MM	MS/MM
NS	BM/MS	BM/MS	MM/MM	MM/MM	MS/MM	MS/MM	SS/MM
ZO	SS/MS	SS/MS	MS/MM	MM/MM	MS/MM	SS/BM	SS/BM
PS	SS/MS	MS/MS	MS/MM	MM/MM	MM/MM	BM/BM	BM/BB
PM	MS/MM	MM/MM	MM/BM	BM/MM	BM/BM	BM/BB	BB/BB
PB	MM/MM	MM/MM	BM/BM	BM/BM	BM/BM	BB/BB	BB/BB

The spherical tank system is connected with the computer through National Instruments Data Acquisition card. In real time experimental studies, 1 analog input channel (AI0) and 1 analog output channel (AO0) are used to control the spherical tank system. In the beginning, the differential pressure transducer measures the water level of the spherical tank. The NI USB 6009 Data acquisition card acceptable input and output voltages are -5V to 5V. The real time servo operation of the spherical tank input flow can be control by using variable frequency drive in automatic control. In the automatic control the frequency of the drive varies based on the control signal between 4 to 20mA. In this purpose, DAQ output voltage is converted between 4 to 20mA by using the voltage to current converter. The real time regulatory operation of the spherical tank input flow can be control by using kinematic control valve (CV-1). The disturbance is given to outflow of the spherical tank by kinematic control valve (CV-2). From the experimental study, the servo and regulatory responses of spherical tank system is obtained by assigning the controller parameters for different range of set points.

### 6. Results and discussion

In this section, discuss the results of servo and regulatory responses of the spherical tank system by different operating region and also analyze the PI controller tuning methods using PI controller tuned by fuzzy logic, root locus technique and Ziegler–Nichols tuning method are discussed. The servo and regulatory responses of spherical tank system for different operating regions are discussed.

#### 6.1 Case: 1 – Lower range set points

The servo response of spherical tank system with various tuning methods for set point (10 cm) is shown in Figure 7. In this case, the real time operation of the spherical tank system takes place for 190 seconds.

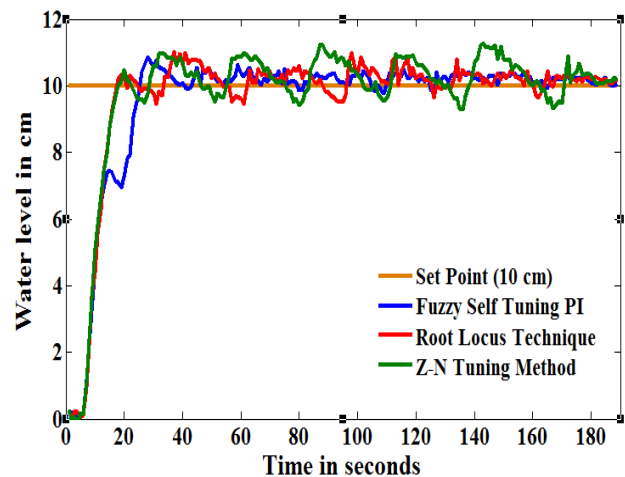

Fig. 7. Servo response of spherical tank system with various tuning methods for set point (10 cm)

The Figure 8 shows the servo response of spherical tank system for different set points (5 cm to 10 cm). In the beginning the set point starts from 5 cm and maintained for 90 seconds, then the set point is changed to 10 cm and it is maintained up to 230 seconds then again the set point is set 5 cm up to 360 seconds. Table 1 shows the comparison of servo responses based on performance indices (set point 10 cm).

Table 4. Servo responses based on Performance Indices - Set Point (10 cm)

Parameters	PI Controller Tuning Methods		
	PI controller tuned by fuzzy logic	Root Locus Technique	Z-N tuning method
Rise time (sec)	<b>7.07</b>	11.67	15.18
Peak time (sec)	<b>27.34</b>	36.45	43.81
Overshoot	<b>7.99</b>	8.42	10.06
Settling time (sec)	<b>186.35</b>	187.35	188.35
Steady state error (cm)	<b>10.04</b>	10.17	11.14
Average IAE	<b>0.829</b>	0.87	0.98
Average ISE	<b>4.61</b>	4.73	4.83

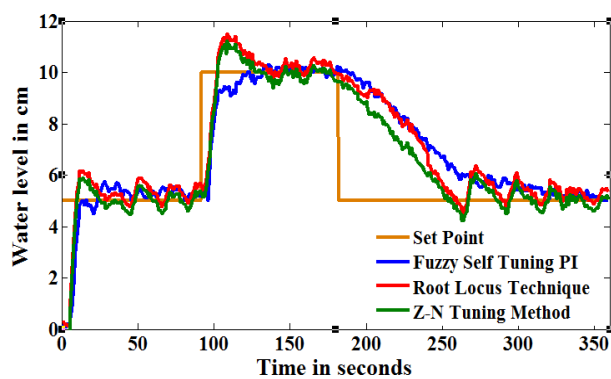

Fig. 8. servo response of spherical tank system for different set points (5 cm to 10 cm)

From the figure 7, 8 and table 4 are evident that, the proposed PI controller tuned by fuzzy logic is superior to reduce by means of rise time, peak time, overshoot, settling time and steady state error, average IAE and average ISE for set point when compared with root locus technique and Z-N tuning method.

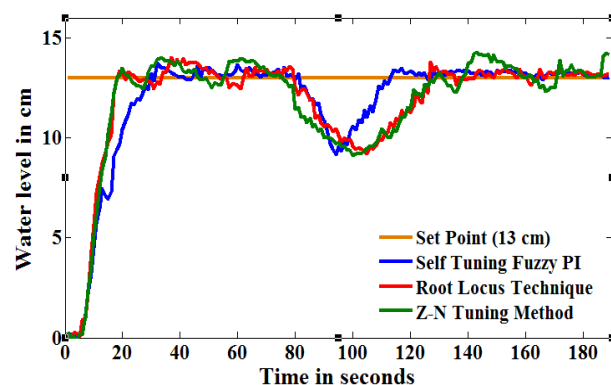

Fig. 9. Regulatory response of spherical tank system with various tuning methods for set point (13 cm)

The regulatory response with various tuning methods of the spherical tank system for set point (13 cm) is shown in Figure 9. In this case the real time operation of the spherical tank system takes place for 190 seconds and the disturbance is given from 80 seconds to 130 seconds. From the figure 10 it is evident that the proposed PI controller tuned by fuzzy logic gives the average IAE is 1.41 and average ISE is 9.37, the root locus technique gives average IAE is 1.48 and average ISE is 9.84 and Z-N tuning method gives average IAE is 1.70 and average ISE is 10.15. Based on the comparison, PI controller tuned by fuzzy logic is superior.

## 6.2 Case: 2 – Middle range set points

The servo response of spherical tank system with various tuning methods for set point (20 cm) is shown in Figure 10. In this case, the real time operation of the spherical tank system takes place for 190 seconds.

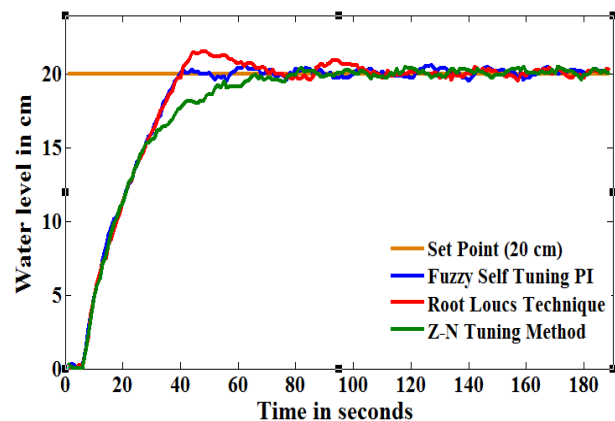

Fig. 10. Servo response of spherical tank system with various tuning methods for set point (20 cm)

Table 5. Servo responses based on Performance Indices - Set Point (20 cm)

Parameters	PI Controller Tuning Methods		
	PI controller tuned by fuzzy logic	Root Locus Technique	Z-N tuning method
Rise time (sec)	<b>26.33</b>	27.34	38.48
Peak time (sec)	<b>37.61</b>	47.61	60.02
Overshoot	<b>2.07</b>	6.54	10.96
Settling time (sec)	<b>179.14</b>	181.28	182.30
Steady state error (cm)	<b>20.18</b>	20.29	20.23
Average IAE	<b>2.15</b>	2.71	3.37
Average ISE	<b>27.35</b>	28.27	29.58

The Figure 11 shows the servo response of spherical tank system for different set points (15cm to 20 cm). In the beginning the set point starts from 15 cm and maintained for 130 seconds, then the set point is changed to 10 cm and it is maintained up to 230 seconds then again the set point is set 15 cm up to 360 seconds. The Table 2 shows the comparison of servo responses based on performance indices (set point 20 cm).

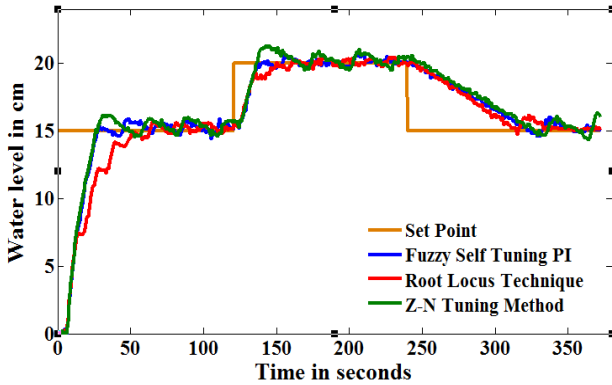

Fig. 11. Servo response of spherical tank system for different set points (15 cm to 20 cm)

From the figure 10, 11 and table 5 are evident that, the proposed PI controller tuned by fuzzy logic is superior to reduce by means of rise time, peak time, overshoot, settling time and steady state error, average IAE and average ISE for set point when compared with root locus technique and Z-N tuning method.

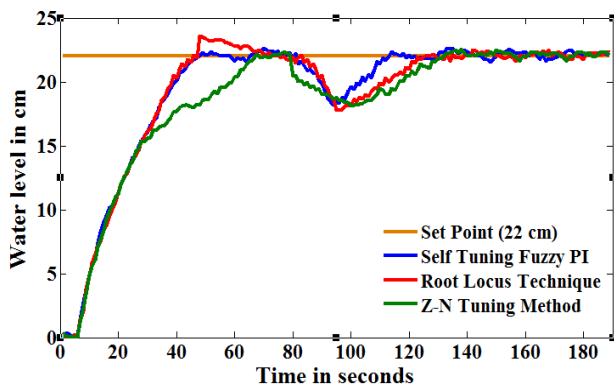

Fig. 12. Regulatory response of spherical tank system with various tuning methods for set point (22 cm)

The regulatory response with various tuning methods of the spherical tank system for set point (22 cm) is shown in Figure 12. In this case the real time operation of the spherical tank system takes place for 190 seconds and the disturbance is given from 80 sec to 130 sec. From the figure 10 it is

evident that the proposed PI controller tuned by fuzzy logic gives the average IAE is 2.86 and average ISE is 36.86, the root locus technique gives average IAE is 3.08 and average ISE is 38.29 and Z-N tuning method gives average IAE is 3.59 and average ISE is 40.51. Based on the comparison, PI controller tuned by fuzzy logic is superior.

### 6.3 Case: 3 – Higher range set points

The servo response of spherical tank system with various tuning methods for set point (32 cm) is shown in Figure 13. In this case, the real time operation of the spherical tank system takes place for 190 seconds.

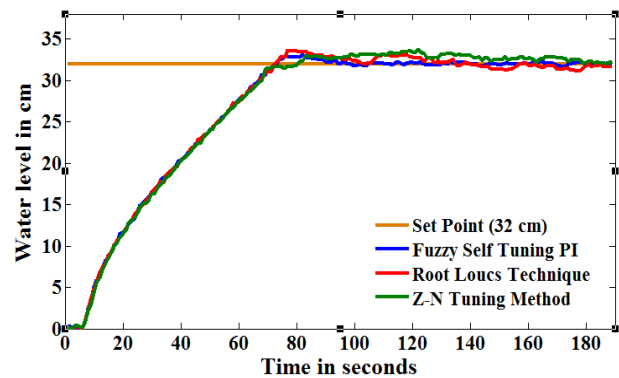

Fig. 13. Servo response of spherical tank system with various tuning methods for set point (32 cm)

The Figure 14 shows the servo response of spherical tank system for different set points (30 cm to 35cm).

Table 6. Servo responses based on Performance Indices - Set Point (32 cm)

Parameters	PI Controller Tuning Methods		
	PI controller tuned by fuzzy logic	Root Locus Technique	Z-N tuning method
Rise time (sec)	<b>53.69</b>	55.70	57.98
Peak time (sec)	<b>82.05</b>	76.98	132.69
Overshoot	<b>3.02</b>	3.15	5.18
Settling time (sec)	<b>174.20</b>	186.34	190.17
Steady state error (cm)	<b>32.10</b>	32.99	33.30
Average IAE	<b>5.52</b>	5.82	5.99
Average ISE	<b>110.57</b>	112.30	114.21

In the beginning the set point starts from 30 cm and maintained for 120 seconds, then the set point is changed to 35 cm and it is maintained up to 240 seconds then again the set point is set 30 cm up to



370 seconds. The Table 2 shows the comparison of servo responses based on performance indices (set point 20 cm). From the figure 13, 14 & table 6 are evident that, the proposed PI controller tuned by fuzzy logic is superior by means of rise time, peak time, overshoot, settling time and steady state error, average IAE and average ISE for 20 cm set point when compared with root locus technique and Z-N tuning method.

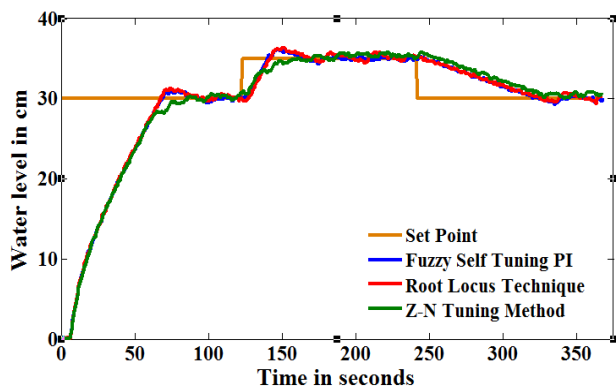

Fig. 14. Servo response of spherical tank system for different set points (15cm to 20cm)

The regulatory response with various tuning methods of the spherical tank system for set point (34 cm) is shown in Figure 15. In this case the real time operation of the spherical tank system takes place for 190 seconds and the disturbance is given from 120 seconds to 165 seconds.

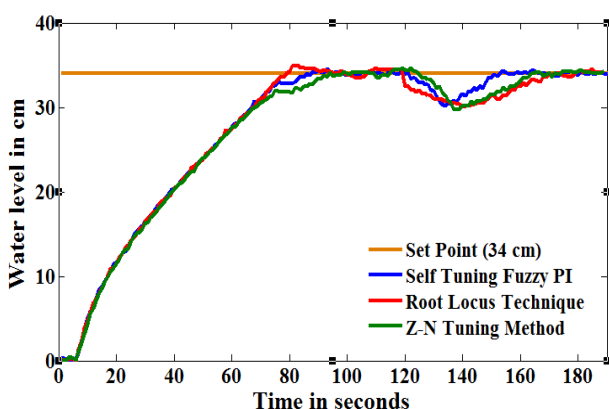

Fig. 15. Regulatory response of spherical tank system with various tuning methods for set point (34 cm)

From the figure 15 it is evident that the proposed PI controller tuned by fuzzy logic gives the average IAE is 6.58 and average ISE is 134.47, the root locus technique gives average IAE is 7.01 and average ISE is 137.32 and Z-N tuning method gives average IAE is 8.00 and average ISE is 140.15. Based on the comparison, PI controller tuned by fuzzy logic is

superior.

## 7. Conclusion

This paper presents water level control of the spherical tank system by real time. The proposed PI controller tuned by fuzzy logic is developed and applied to the water level control of the spherical tank system successfully. The better performance and higher control precision have been obtained in servo operation and regulatory operation compared with conventional Root Locus Technique (RLT) and Ziegler-Nichols (Z-N) tuning method. The experiments carried out to evaluate the effectiveness of the PI controller tuned by fuzzy logic method for water level control of the spherical tank system. The experimental results of servo and regulatory responses demonstrate by means of performance indices the proposed PI controller tuned by fuzzy logic is superior to conventional PI controller tuned by Root Locus Technique (RLT) and Ziegler-Nichols (Z-N) tuning method.

## References

1. Anandanatarajan, R, Chidambaram, M & Jayasingh, T: *Design of controller using variable transformations for a nonlinear process with dead time*. In: ISA Transactions, Vol. 44, Issue 1, 2005, p. 81-91.
2. Anandanatarajan, R, Chidambaram, M & Jayasingh, T : *Limitations of a PI controller for a first-order nonlinear process with dead time*. In: ISA Transactions, Vol. 45, no. 2, 2006, p. 185-199.
3. Basilio, JC & Matos, SR: *Design of PI and PID controllers with transient performance specification*. In: IEEE Transactions on Education, vol. 45, no. 4, 2006, p. 364-370.
4. Chen, KY, Tung, PC, Tsai, MT & Fan, YH: *A self-tuning fuzzy PID-type controller design for unbalance compensation in an active magnetic bearing*: In: Expert Systems with Applications, Vol. 36, no. 4, 2009, p. 8560-8570.
5. Dinesh Kumar, D & Meenakshipriya, B: *Design and Implementation of Non Linear System Using Gain Scheduled PI Controller*. In: Procedia Engineering, Vol. 38, 2012, p. 3105-3112.
6. Prasanta Roy & Binoy Krishna Roy: *Fractional order PI control applied to level control in coupled*

- two tank MIMO system with experimental validation. In: Control Engineering Practice, Vol. 48, 2016, p. 119-135.
7. Danica Rosinova, Peter Balko & Teofana Puleva: *Teaching multiloop control of nonlinear system: three tanks case study*. In: IFAC Papers on line, Vol. 49-6, 2016, p. 360-365.
  8. Houssemeddine Gouta, Salim Hadj Saïd, Nabil Barhoumi & Faouzi M'Sahli: *Generalized predictive control for a coupled four tank MIMO system using a continuous-discrete time observer*. In: ISA Transactions, Vol. 67, 2017, p. 280-292
  9. Pradeep K. Junej, Mayank Chaturvedi, M. Gupta & Nitesh Shah: *Set-point tracking capability comparison of PI and PID controllers for a FOPDT process model*. In: IEEE Conference, 2016.
  10. Dharmana.Simhachalam & Rajani KM: *Self-tuning Fuzzy PID Controller for Integrating Processes* In: International Conference on Control, Instrumentation, Energy & Communication, 2014.
  11. Rajni Jain, N, Sivakumaran, & T.K, Radhakrishnan: *Design of self tuning fuzzy controllers for nonlinear systems*. In: Expert Systems with Applications, Vol 38, no. 4, 2011, p. 4466-4476.
  12. Taoyan ZHAO, Ping LI & Jiangtao CAO: *Study of Interval Type-2 Fuzzy Controller for the Twin-tank Water Level System*. In: Chinese Journal of Chemical Engineering Volume 20, no. 6, 2012, p. 1102-1106.
  13. Precup, Radu-Emil, Tomescu, Marius L, Preitl, Stefan, Petriu, Emil M, Fodor, János & Pozna, Claudiu: *Stability analysis and design of a class of MIMO fuzzy control systems*. In: Journal of Intelligent & Fuzzy Systems, vol. 25, no. 1, 2013, p. 145-155.
  14. Abdullah Basci & Adnan Derdiyok: *Implementation of an adaptive fuzzy compensator for coupled tank liquid level control system*. In: Measurement Vol. 91, 2016, p. 12-18.
  15. Mudi, RK & Pal, NR: *A self-tuning fuzzy PI controller*. In: Fuzzy Sets and Systems, Vol. 115, no. 2, 2000, p. 327-338.
  16. Zaky, MS: *A self-tuning PI controller for the speed control of electrical motor drives*: In. Electric Power Systems Research, Vol. 119, 2015, p. 293-303.
  17. Zheng, JM, Zhao, SD & Wei, SG: *Application of self-tuning fuzzy PID controller for a SRM direct drive volume control hydraulic press*. In: Control Engineering Practice, Vol. 17, no. 12, 2009, p. 1398-1404.
  18. Selvaraj, SP & Nirmalkumar, A: *Constrained GA Based Online PI Controller Parameter Tuning for Stabilization of Water Level in Spherical Tank System*. In: International Journal of Mechanical & Mechatronics Engineering, Vol. 15, no. 01, 2015, p. 19-31.
  19. Lakshmanan, M & Ganesan, R: *Implementation of Proportional Integral Controller Parameter Tuning for Spherical Tank System using Root Locus Technique*. In: Asian Journal of Research in Social Sciences and Humanities, Vol.6, no. 6, 2016, p. 85-103.
  20. Lakshmanan,M & Ganesan.R: *Design of controllers for Dual Motor Ball and Beam System*. In: International Review of Mechanical Engineering (IREME), Vol 8, No. 4, 2014, p. 714-721.
  21. Madhavasarma, P & Sundaram,S: *Model Based Tuning of a Non Linear Spherical Tank Process with Time Delay*. In: Instrumentation Science and Technology, vol. 36, no. 4, 2008, p. 420-431.
  22. Nithya,S, Sivakumaran, N, Balasubramanian, T & Anantharaman, N: *Model Based Controller Design for a Spherical Tank Process in Real Time*. In:International Journal of Simulation Systems, Science and Technology, vol. 9, no. 4, 2008, p. 25-31.
  23. Ravi, V.R, Thyagarajan, T & Uma Maheshwaran, G: *Dynamic Matrix Control of a Two Conical Tank Interacting Level System*. In: Procedia Engineering, vol. 38, 2012, p. 2601 – 2610.
  24. Astrom.K.J & Hagglund.T: *Revisiting the Ziegler–Nichols step response method for PID control*. In: Journal of Process Control, vol. 14, 2004, p. 635–650.
  25. Katsuhiko Ogata: *Modern Control Engineering*, prentice hall, New York, 2010.